

PXIe VNA

PXIe-S5090

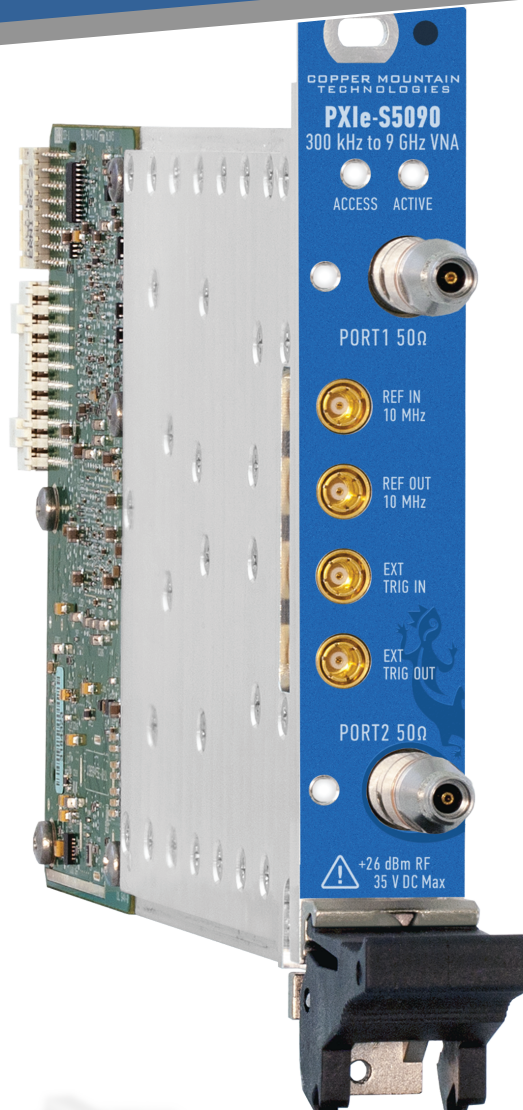

- **Frequency range:** 300 kHz - 9 GHz
- **Wide output power adjustment range:** -45 dBm to +13 dBm
- **Dynamic range:** 138 dB (10 Hz IF bandwidth) typ.
- **Measurement time per point:** 16 μ s per point, min typ.
- Up to **16 logical channels with 16 traces** each max
- **Automation programming** in LabVIEW, IVI drivers, IVI-C drivers, IVI.NET drivers

- **Time domain and gating** conversion included
- **Frequency offset mode**, including vector mixer calibration measurements
- Up to **500,001 measurement points**
- Multiple **precision calibration** methods and automatic calibration

EXTEND YOUR REACH™

USA: +1.317.222.5400
info@coppermountaintech.com

631 E. New York St | Indianapolis, IN | 46202
www.coppermountaintech.com

Singapore: +65.6323.6546
Latin America: +1.954.706.5920

Full featured lab grade performance in a compact package

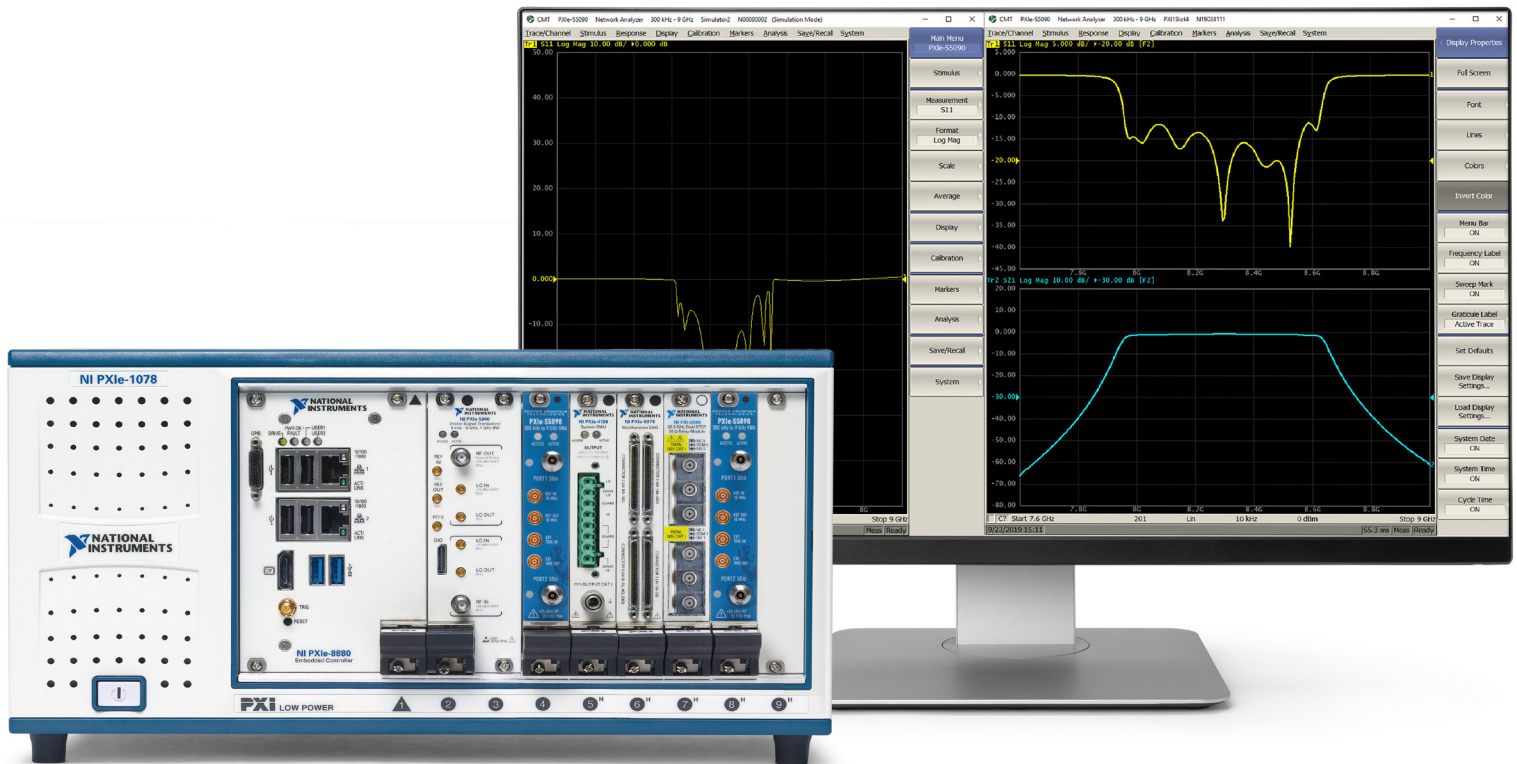

PXIe VNAs deliver lab grade performance in a compact package, with all the features engineers have come to expect included: time domain and gating conversion, segmented frequency sweeps, linear/logarithmic sweeps, power sweeps, multiple trace formats, 16 channels max. with up to 16 traces each, marker math, and limit tests.

Versatile Copper Mountain Technologies' analyzers are ideal for laboratory and production testing in a wide variety of industries including design and production of RF components, cable CPEs, medical devices, aerospace, etc.

Copper Mountain Technologies' PXIe VNAs are next generation analyzers designed to meet the needs of 21st Century engineers. It includes an RF measurement module and a processing module, a software application.

This innovative approach delivers high measurement accuracy and enables users to take advantage of faster processors, newer computers, and larger displays.

CMT PXIe-S5090 fits into one slot of NI chassis. All the measurement data is processed on the controller or PC. This eliminates the need for data purging or hard drive removal in secure environments.

Software Application

Software application is part of the VNA

The software application takes raw measurement data from the data acquisition (measurement) module and recalculates into S-parameters in multiple presentation formats utilizing proprietary algorithms. These new and advanced calibration and other accuracy enhancing algorithms were developed by our metrology experts. Our software can be downloaded free from our website, used on an unlimited number of PCs using either Linux or Windows operating systems, and enables easy VNA integration with other software applications and automation.

The software application features a fully functioning Demo Mode, which can be used for exploring VNAs' features and capabilities without an actual measurement module connected to your PC.

Measurement Capabilities

Measured parameters:

$$S_{11}, S_{21}, S_{12}, S_{22}$$

All models also measure absolute power of the reference and received signals at the port.

Number of measurement channels

Up to 16 independent logical channels: each logical channel is represented on the screen as an individual channel window. A logical channel is defined by such stimulus signal settings as frequency range, number of test points, or power level.

Data traces

Up to 16 data traces can be displayed in each channel window. A data trace represents one of such parameters of the DUT as S-parameters, response in time domain, or input power response.

Memory traces

Each of the 16 data traces can be saved into memory for further comparison with the current values.

Data display formats

Logarithmic magnitude, linear magnitude, phase, expanded phase, group delay, SWR, real part, imaginary part, Smith chart diagram and polar diagram display formats are available.

Dynamic Range

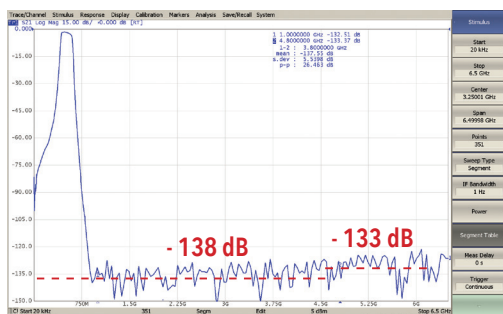

Typical dynamic range of 138 dB is achieved from 1 MHz to 6.5 GHz (at 10 Hz IF bandwidth). Seen here is the maximum dynamic range achieved when using IFBW 1 Hz and an output power level of 5 dBm.



Software Application

Sweep Features

Sweep type: Linear frequency sweep and logarithmic frequency sweep are performed with fixed output power. Linear power sweep is performed at a fixed frequency.

Measured points per sweep: Set by the user from 2 to 500,001.

Segment sweep features: A frequency sweep within several independent user-defined segments. Frequency range, number of sweep points, source power, and IF bandwidth can be set for each segment.

Output Power: Source power from -45 dBm to 13 dBm from 300 kHz to 6.5 GHz with a resolution of 0.05 dB. In frequency sweep mode power slope can be set up to 2 dB/GHz to compensate for high frequency attenuation in fixture cables.

Sweep Trigger:

Trigger modes: continuous, single, or hold.

Trigger sources: internal, manual, external, bus.

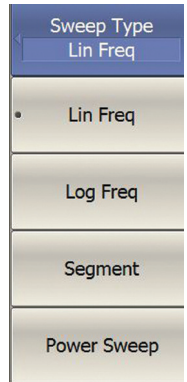

Trace Functions

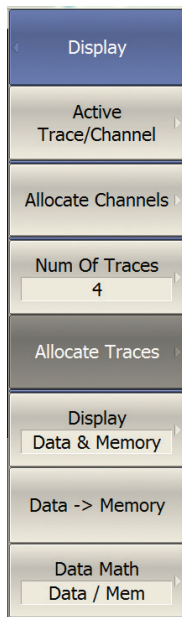

Trace display

Data trace, memory trace, or simultaneous indication of data and memory traces.

Trace math

Data trace modification by math operations: addition, subtraction, multiplication or division of measured complex values and memory data.

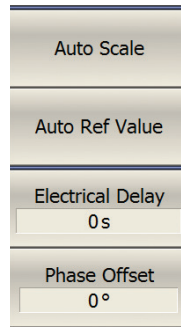

Autoscaling

Automatic selection of scale division and reference level value to have the trace most effectively displayed.

Electrical delay

Calibration plane moving to compensate for the delay in the test setup. Compensation for electrical delay in device under test (DUT) during measurements of deviation from linear phase.

Phase offset

Defined in degrees.

Frequency Scan Segmentation

The VNA has a large frequency range with the option of frequency scan segmentation. This allows for optimal use of the device to realize the maximum dynamic range while maintaining high measurement speed.

Power Scanning & Compression Point Recognition

The power sweep feature turns compression point recognition, one of the most fundamental and complex amplified measurements, into a simple and accurate operation.

Software Application

Mixer/Converter Measurements

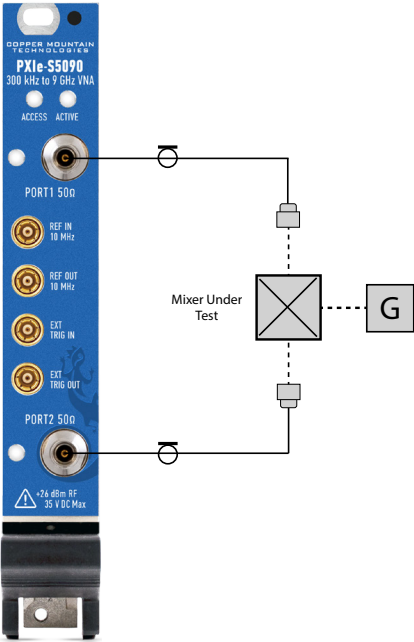

Scalar mixer/converter measurements

The scalar method allows the user to measure only the magnitude of the transmission coefficient of the mixer and other frequency translating devices. No external mixers or other devices are required. The scalar method employs port frequency offset when there is a difference between the source port frequency and the receiver port frequency.

Scalar mixer/converter calibration

This is the most accurate method of calibration applied for measurements of mixers in frequency offset mode. The OPEN, SHORT, and LOAD calibration standards are used. An external power meter should be connected to the USB port directly or via USB/GPIB adapter.

Vector mixer/converter measurements

The vector method allows the measurement of both the magnitude and phase of the mixer transmission coefficient. This method requires an external mixer and an LO common for both the external mixer and the mixer under test.

Vector mixer/converter calibration

This method of calibration is applied for vector mixer measurements. OPEN, SHORT, and LOAD calibration standards are used.

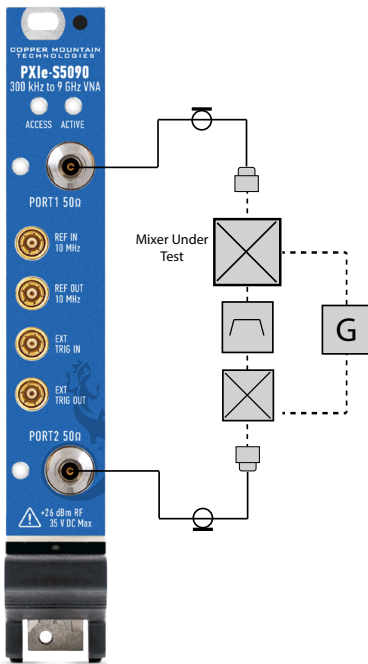

Automatic frequency offset adjustment

This function performs automatic frequency offset adjustment when the scalar mixer/converter measurements are performed to compensate for internal LO setting inaccuracy in the DUT.

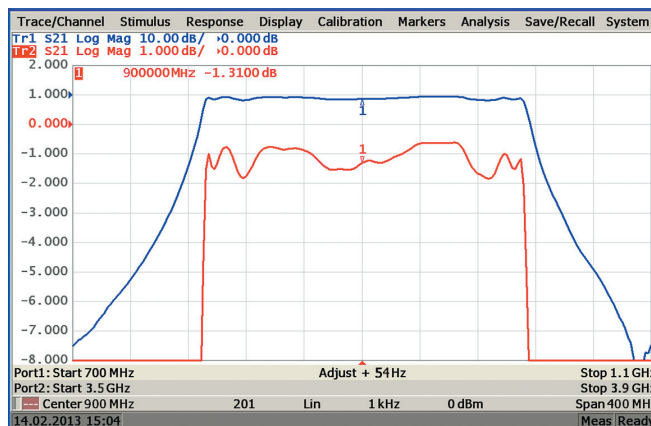

Software Application

Time Domain Measurements

This function performs conversion of response of the DUT to various stimulus types from frequency domain into time domain. Modeled stimulus types are bandpass, lowpass impulse, and lowpass step. The time domain span is arbitrarily between zero to maximum, which is determined by the frequency step. Windows of various shapes are used for tradeoff between resolution and levels of spurious sidelobes.

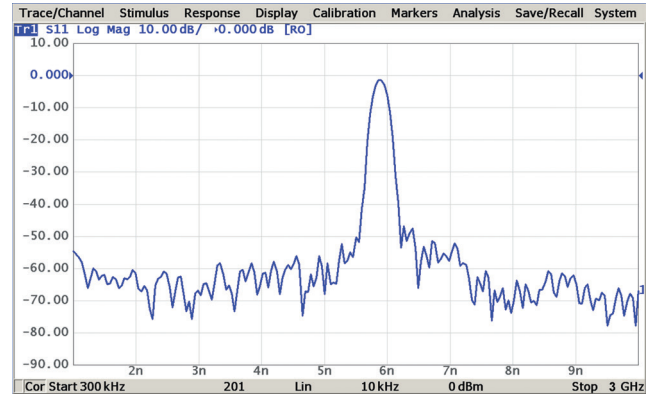

Here, built-in time domain analysis allows the user to detect a physical impairment in a cable.

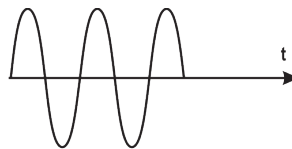
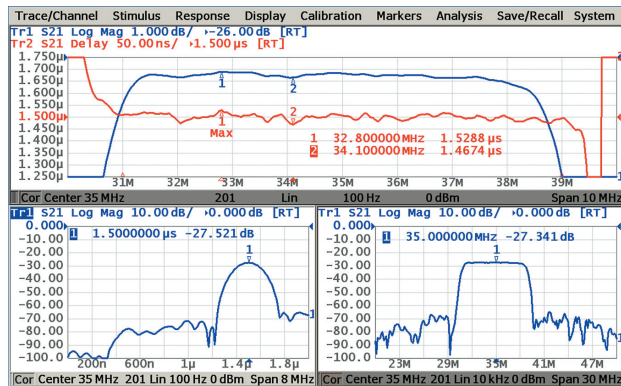

Time domain analysis allows measurements of SAW filters such as the time delay and feedthrough signal suppression.

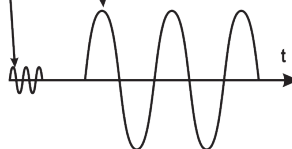
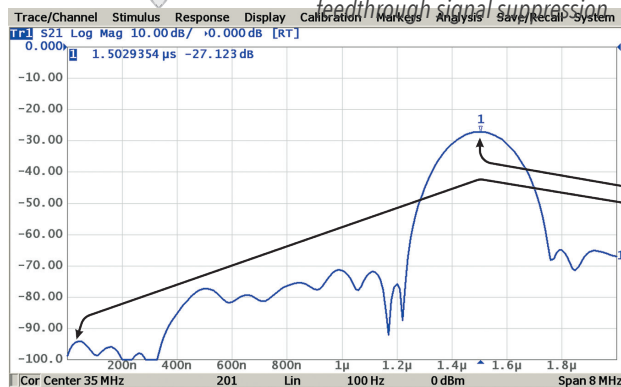
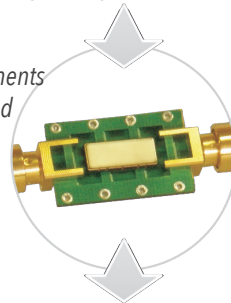

Time Domain Gating

This function mathematically removes unwanted responses in the time domain, which allows the user to obtain a frequency response without effects of fixture elements.

This function applies reverse transformation back to the frequency domain after cutting out the user-defined span in the time domain. Gating filter types are bandpass or notch. For a better tradeoff between gate resolution and level of spurious sidelobes the following filter shapes are available: maximum, wide, normal and minimum.

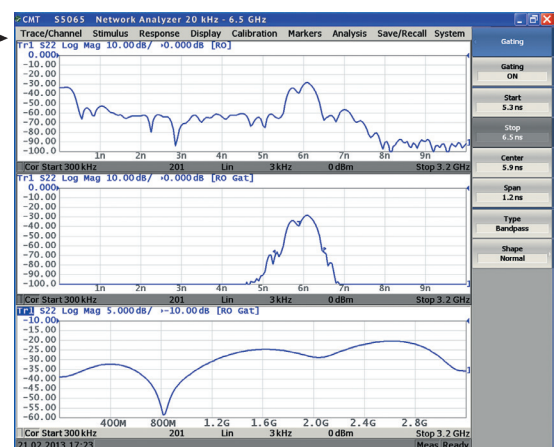

Applications of these features include, but are not limited to: measurements of SAW filter parameters, such as filter time delay or forward transmission attenuation.

Software Application

Limit Testing

Limit testing is a function for automatic pass/fail based on measurement results. Pass/fail is based on comparison of the trace to the limit line set by the user and can consist of one or several segments.

Each segment checks the measurement value for failing either the upper or lower limit, or both. The limit line segment is defined by specifying the coordinates of the beginning (X0, Y0) and the end (X1, Y1) of the segment, and type of the limit. The MAX or MIN limit types check if the trace falls outside of the upper or lower limit, respectively.

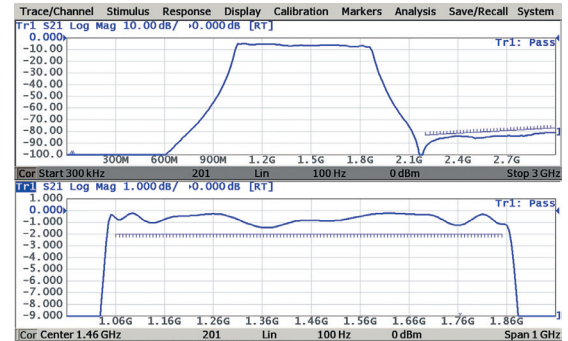

Embedding

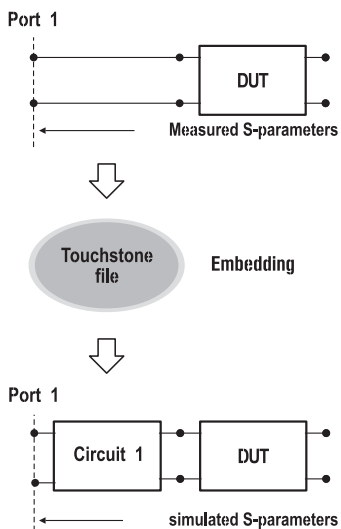

Allows the user to mathematically simulate the DUT parameters after virtual connection through a fixture circuit between the calibration plane and the DUT. This circuit is described by an S-parameter matrix in a Touchstone file.

De-Embedding

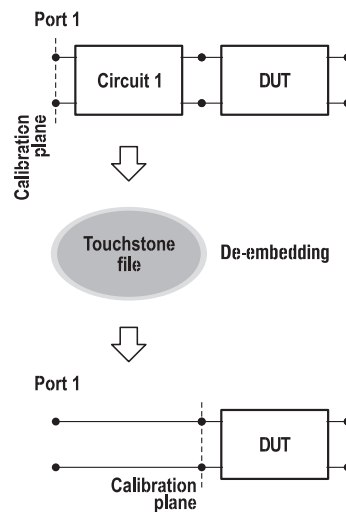

Allows users to mathematically exclude from the measurement result the effect of the fixture circuit connected between the calibration plane and a DUT. This circuit should be described by an S-parameter matrix in a Touchstone file.

Port Impedance Conversion

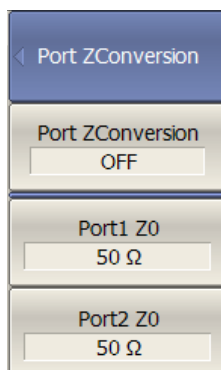

This function converts the S-parameters measured at a 50 or 75 Ω port into values which would be seen if measured at a test port with arbitrary impedance.

S-Parameter Conversion

This function allows for conversion of measured S-parameters to the following parameters: reflection impedance and admittance, transmission impedance and admittance, and inverse S-parameters.

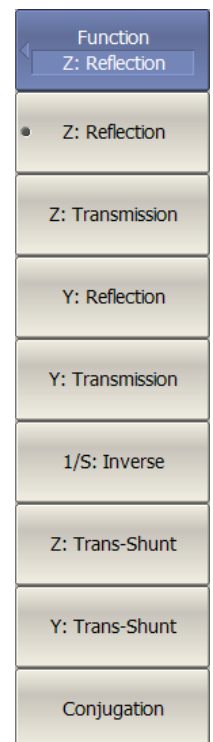

Software Application

Data Output

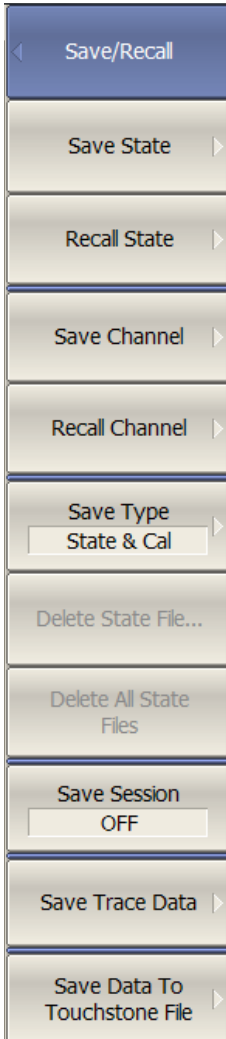

Analyzer State

All state, calibration and measurement data can be saved to an Analyzer state file on the hard disk and later recalled into the software program. The following four types of states are available: State, State & Cal, Stat & Trace, or All.

Channel State

A channel state can be saved into the Analyzer state. The procedure is similar to saving of the Analyzer state, and the same types are applied to channel state saving. Unlike Analyzer state, channel state is saved into the Analyzer volatile memory (not to the hard disk) and is cleared when power to the Analyzer is switched off. For channel state, there are four memory registers A, B, C, D. Channel state saving allows the user to easily copy the settings of one channel to another one.

Trace Data CSV File

The Analyzer allows the user to save an individual trace's data as a CSV file (comma separated values). The active trace stimulus and response values, in its current format are saved to a *.CSV file.

Trace Data Touchstone File

Allows the user to save S-parameters to a Touchstone file. The Touchstone file contains frequency values and S-parameters. Files of this format are industry-standard for most circuit simulator programs. The .s2p files are used for saving all S-parameters of a device. The .s1p files are used for saving S_{11} or S_{22} parameters of a 1-port device. The Touchstone file saving function is applied to individual channels. In addition, the software can be used as a Touchstone file viewer, which allows the user to graphically display and work with previously saved Touchstone files.

Screenshot capture

A print function is provided with a preview feature, which allows for viewing the image to be printed on the screen, and/or save it to a file. Screenshots can be printed using three different applications: MS Word, Image Viewer for Windows, or the Print Wizard of the Analyzer. Each screenshot can be printed in color, grayscale, black and white, or inverted for visibility or to save ink. The current date and time can be added to each capture before it is transferred to the printing application, resulting in quick and easy test reporting.

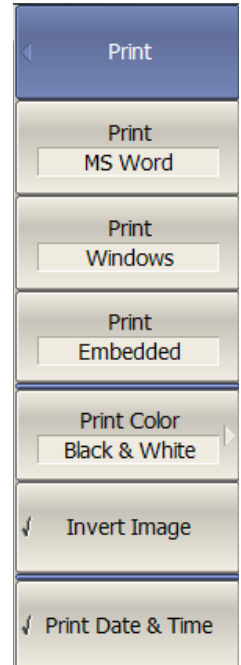

Calibration

User Calibration

Calibration

Calibration of a test setup (which includes the VNA, cables, and adapters) significantly increases the accuracy of measurements. Calibration allows for correction of errors caused by imperfections in the measurement system: system directivity, source and load match, tracking, and isolation.

Calibration methods

The following calibration methods of various sophistication and accuracy are available:

- Reflection & transmission normalization
- Full one-port calibration
- One-path two-port calibration
- Full two-port calibration

Reflection and transmission normalization

This is the simplest calibration method; however, it provides reduced accuracy compared to other methods.

Full one-port calibration

Method of calibration performed for one-port reflection measurements. It ensures high accuracy.

One-path two-port calibration

Method of calibration performed for reflection and one-way transmission measurements, for example for measuring S_{11} and S_{21} only. It ensures high accuracy for reflection measurements, and moderate accuracy for transmission measurements.

Full two-port calibration

This method of calibration is performed for full S-parameter matrix measurement of a two-port DUT, ensuring high accuracy.

TRL calibration

Method of calibration performed for full S-parameter matrix measurement of a two-port DUT. It ensures higher accuracy than two-port calibration. LRL and LRM modifications of this calibration method are available.

Mechanical Calibration Kits

The user can select one of the predefined calibration kits of various manufacturers or define a new calibration kit.

Automatic Calibration Modules

Electronic, or automatic, calibration modules offered by CMT make calibration faster and easier than traditional mechanical calibration.

Sliding load calibration standard

The use of a sliding load calibration standard allows for a significant increase in calibration accuracy at high frequencies compared to the fixed load calibration standard.

"Unknown" thru calibration standard

The use of a generic two-port reciprocal circuit instead of a characterized Thru in full two-port calibration allows the user to calibrate the VNA for measurement of "non-insertable" devices.

Defining of calibration standards

Different methods of calibration standard definition are available: standard definition by polynomial model and standard definition by data (S-parameters).

Error correction interpolation

When the user changes any settings such as the start/stop frequencies or the number of sweep points, compared to the settings at the moment of calibration, interpolation or extrapolation of the calibration coefficients will be applied.

Power calibration

Power calibration allows more stable power level setting at the DUT input. An external power meter should be connected to the USB port directly or via a USB/GPIB adapter.

Receiver calibration

This method calibrates the receiver gain at the absolute signal power measurement.

Automation

Automation Languages

PXIe VNA offers several formats for automation:

- IVI driver
- IVI.NET driver
- IVI-C driver
- LabVIEW driver

The IVI drivers provide the standardized by IVI Foundation programming interface for measuring and testing equipment. The IVI drivers can be used when the PXI VNA is controlled locally through an embedded PXI controller. The automation program opens IVI driver using the name of instrument in a PXI system like "Pxi1Slot5" or "MyVNA". The IVI driver automatically launches the VNA software in invisible mode. The IVI driver realizes high level programming interface above the SCPI command set of the VNA. Also the automation program has ability to send SCPI commands to VNA via so called SCPI pass through interface of the IVI-C driver. The IVI driver can operate without the presence of an actual instrument by using the simulation mode of the VNA software.



The SCPI command set via HiSLIP or Socket network protocols

The Standard Commands for Programmable Instruments (SCPI) is a textual command language for controlling measuring and testing equipment. The SCPI commands are sent to PXI VNA via HiSLIP or TCP/IP Socket network protocols. SCPI commands can be used to control PXI VNA either from a remote host or locally through an embedded PXI controller. The VNA software must be launched in advance and HiSLIP protocol and/or Socket protocol must be enabled. The automation program opens communication with the PXI VNA using VISA address of the instrument (for example "TCPIP0::192.168.0.1::hislip0::INSTR").

High-Speed LAN Instrument Protocol (HiSLIP) is a specialized TCP/IP network protocol developed for the remote control of measuring and testing equipment. HiSLIP provides high speed, reliable error detection and recovery. The automation program, as a rule, relies on the implementation of the HiSLIP protocol in the VISA library.

TCP/IP Socket is a general-purpose network protocol. It is supported by many programming languages and can be used without VISA library.

The SCPI command can also be tested without the presence of an actual instrument by using the demo mode of the VNA software.

Electromagnetic Compatibility Guidelines

This product was tested and complies with the regulatory requirements and limits for electromagnetic compatibility (EMC) as stated in the product specifications. These requirements and limits are designed to provide reasonable protection against harmful interference when the product is operated in its intended operational electromagnetic environment.

This product is intended for use in industrial locations. There is no guarantee that harmful interference will not occur in a particular installation, when the product is connected to a test object, or if the product is used in residential areas. To minimize the potential for the product to cause interference to radio and television reception or to experience unacceptable performance degradation, install and use this product in strict accordance with the instructions in the product documentation.

Furthermore, any changes or modifications to the product not expressly approved by Copper Mountain Technologies could void your authority to operate it under your local regulatory rules.



Caution

To ensure the specified EMC performance, operate this product only with shielded cables and accessories.

Electromagnetic Compatibility

This product meets the requirements of the following EMC standards for electrical equipment for measurement, control, and laboratory use:

- EN 61326-1 (IEC 61326-1): Class A emissions; Basic immunity 1
- EN 55011 (CISPR 11): Group 1, Class A emissions
- AS/NZS CISPR 11: Group 1, Class A emissions
- FCC 47 CFR Part 15B: Class A emissions
- ICES-001: Class A emissions

Technology is supposed to move. It's supposed to change and update and progress. It's not meant to sit stagnant year after year simply because that's how things have always been done.

The engineers at Copper Mountain Technologies are creative problem solvers. They know the people using VNAs don't just need one giant machine in a lab. They know that VNAs are needed in the field, requiring portability and flexibility. Data needs to be quickly transferred, and a test setup needs to be easily automated and recalled for various applications. The engineers at Copper Mountain Technologies are rethinking the way VNAs are developed and used.

Copper Mountain Technologies' USB VNAs are designed to work with the Windows or Linux PC you already use via USB interface. After installing the test software, you have a top-quality VNA at a fraction of the cost of a traditional analyzer. The result is a faster, more effective test process that fits into the modern workspace. This is the creativity that makes Copper Mountain Technologies stand out above the crowd.

We're creative. We're problem solvers.



631 E. New York St | Indianapolis, IN | 46202
www.coppermountaintech.com

USA: +1.317.222.5400
Singapore: +65.6323.6546
Latin America: +1.954.706.5920